

Technische Fiche

Rechthoekige kanaalventilatoren EC



Clima Construct heeft een divers aanbod van industriële ventilatoren. Er zijn onder andere boxventilatoren, buisventilatoren, destratificatoren, dakventilatoren, ringventilatoren en wandventilatoren. Hieronder worden enkele rechthoekige kanaalventilatoren met EC-motor verder besproken.

Kanaalventilatoren met achterwaarts gekromde schoepen en EC-motor- KRWEC

- Hoge capaciteits radiaalwielen met hoog rendement.
- Uitzwenkbare motor-schoepenwieleenheid.
- Verkrijgbaar in 11 types in 7 groottes
- $V = 500 - 12000 \text{ m}^3/\text{h}$
- Voor het verplaatsen van grotere volumes in afzuig- en buiteninstallaties.
- Geschikt voor het verplaatsen van vervuilde lucht.

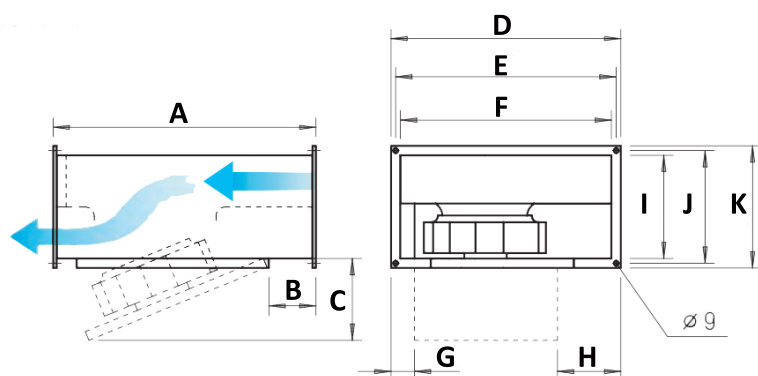

	A	B	C	D	E	F	G	H	I	J	K
KRWEC180	375	80	265	343	322	300	20	72	150	172	193
KRWEC225	502	148	325	443	422	400	19	113	200	222	243

Rechthoekige kanaalventilatoren

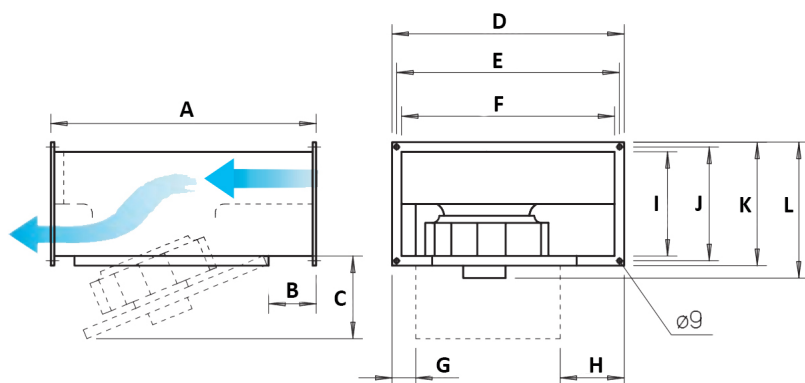

	A	B	C	D	E	F	G	H	I	J	K	L
KRWEC315	532	50	455	543	522	500	36	126	250	272	292	293
KRWEC355	642	34	567	643	622	600	31	171	300	322	343	386
KRWEC400	642	34	567	643	622	600	31	171	350	372	393	441
KRWEC450	787	39	716	743	722	700	19	139	400	422	443	493
KRDEC450												
KRDEC500A	912	34	841	843	822	800	24	174	500	522	543	595
KRDEC500B												606

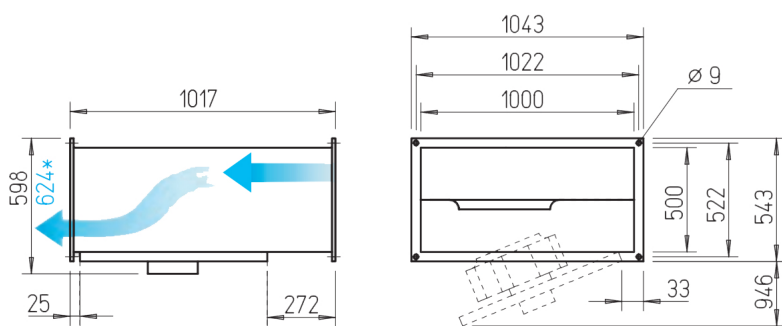

KR EC 560 A, *KR EC 560 B

		KRWEC180/30/15	KRWEC225/40/20	KRWEC315/50/25
Voltage/Frequentie	V/50 Hz	230	230	230
Fase	~	1	1	1
Nominaal vermogen	W	110	160	160
Nominaalstroom	A	0,90	1,26	1,24
Capaciteit	m ³ /h	660	1430	1410
Toerental	1/min	3700	2650	3080
Geluidsdrukkniv. op 1m	dB(A)	44	46	44
Gewicht	kg	6,2	9,8	13,8
Temperatuur	° C	60	60	60

Rechthoekige kanaalventilatoren



KRW EC 180/30/15

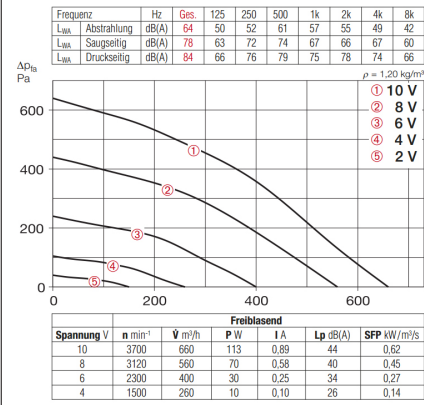

KRW EC 225/40/20

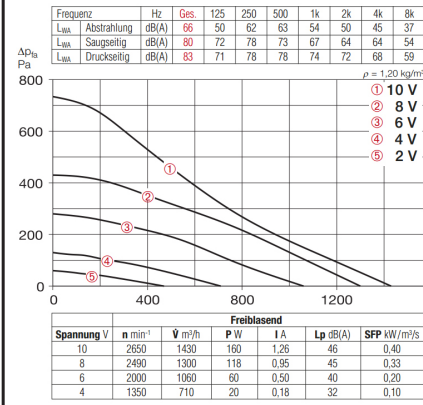

KRW EC 315/50/25

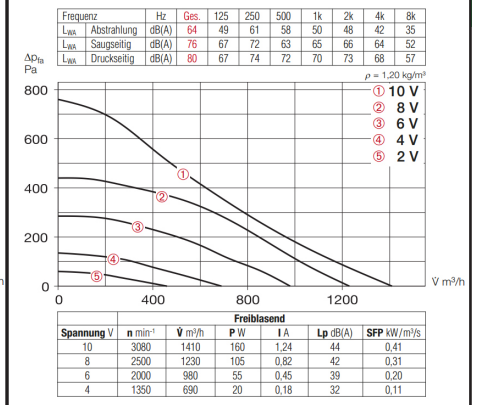

		KRWEC355/60/30	KRWEC400/60/35	KRWEC450/70/40
Voltage/Frequentie	V/50 Hz	230	230	230
Fase	~	1	1	1
Nominaal vermogen	W	370	880	720
Nominaalstroom	A	1,59	4,04	3,29
Capaciteit	m ³ /h	3110	4460	5450
Toerental	1/min	1650	2200	1420
Geluidsdrukkniv. op 1m	dB(A)	46	56	46
Gewicht	kg	25,0	30,4	40,0
Temperatuur	° C	60	60	60

KRW EC 355/60/30

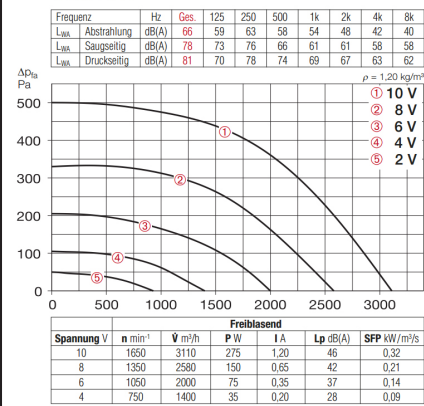

KRW EC 400/60/35

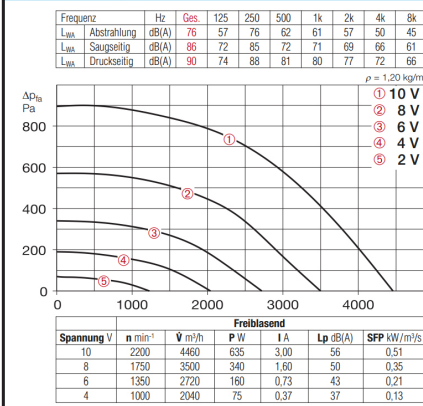

KRW EC 450/70/40

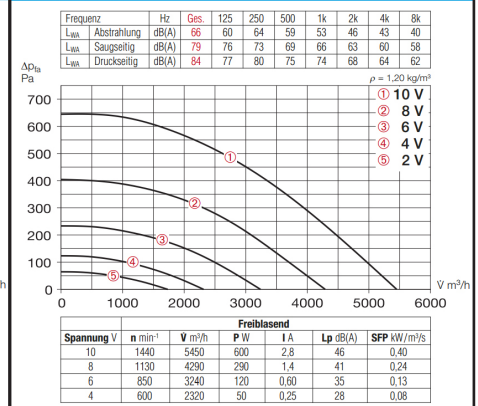

Rechthoekige kanaalventilatoren

		KRDEC450/70/40	KRDEC500/80/50A	KRDEC500/80/50B
Voltage/Frequentie	V/50 Hz	400	400	400
Fase	~	3	3	3
Nominaal vermogen	W	1500	1260	2570
Nominaalstroom	A	2,30	1,96	3,92
Capaciteit	m ³ /h	7480	8810	10400
Toerental	1/min	2300	1400	1800
Geluidsdrukkniv. op 1m	dB(A)	54	51	60
Gewicht	kg	40	55,6	55
Temperatuur	° C	60	60	60

KRD EC 450/70/40

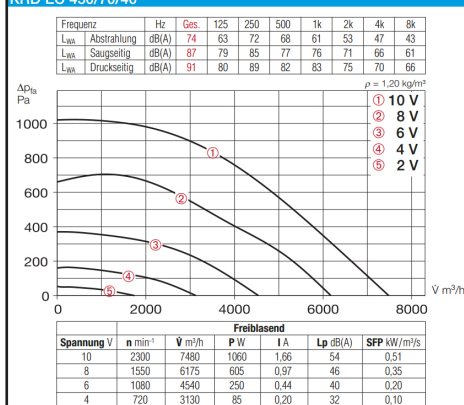

KRD EC 500/80/50 A

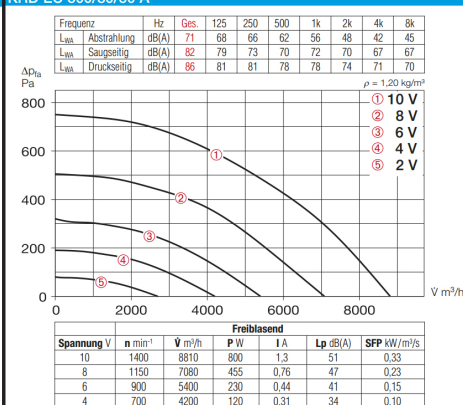

		KRDEC560/100/50A	KRDEC560/100/50B
Voltage/Frequentie	V/50 Hz	400	400
Fase	~	3	3
Nominaal vermogen	W	1570	3450
Nominaalstroom	A	2,45	5,20
Capaciteit	m ³ /h	11270	14410
Toerental	1/min	1230	1630
Geluidsdrukkniv. op 1m	dB(A)	54	60
Gewicht	kg	70,8	83
Temperatuur	° C	60	60

KRD EC 560/100/50 A

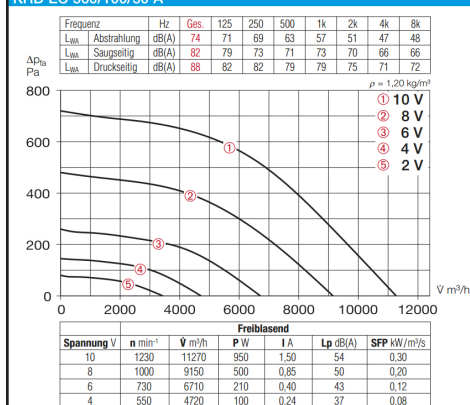

KRD EC 560/100/50 B

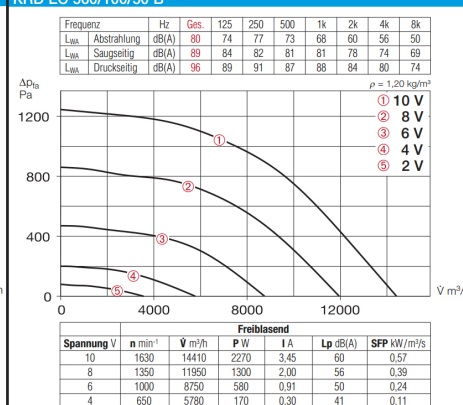

Rechthoekige kanaalventilatoren

Geluidgeïsoleerde kanaalventilatoren met EC-motor - SKREC



- Hoog capaciteits radiaalwielen - achterwaarts gekromd in geluidgeïsoleerd huis met goede dempings-eigenschappen.
- V = 4000 - 12000 m³/h
- Voor het verplaatsen in afzuig- en buiteninstallaties met specifieke eisen aan het geluidsniveau.
- Gebruik van 50 mm dikke huis-isolatie van steenwol.

Deze ventilatoren zijn beschikbaar in volgende uitvoeringen:

- 1-fasig (wisselstroom) 230 V, 50 Hz:

SKRWEC315/50/25 - SKRWEC355/60/30 - SKRWEC400/60/35 - SKRWEC450/70/40

- 3-fasig, 230/400 V, 50 Hz:

SKRDEC355/60/30 - SKRDEC400/60/35 - SKRDEC450/70/40A - SKRDEC500/80/50A - SKRDEC500/80/50B - SKRDEC560/100/50A - SKRDEC560/100/50B